

**Heavy Duty  
Differential Pressure Manometer**

**Model 407910**

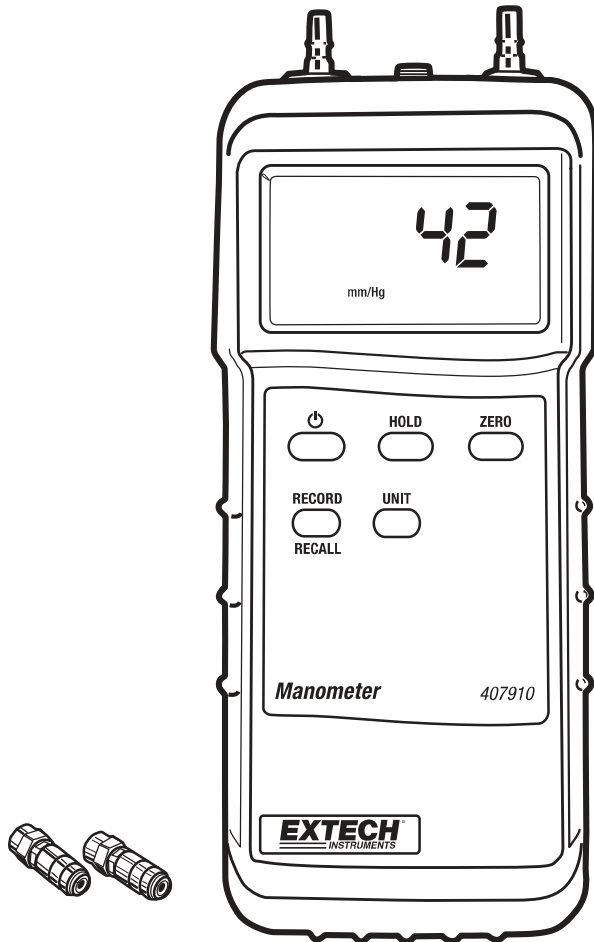

## Introduction

Congratulations on your purchase of the Extech Manometer Model 407910. This device has a differential input with convenient quick-disconnect fittings. Eight units of measure are selectable by front panel pushbutton. Advanced features include Data hold, MAX/MIN record/recall, and RS-232 PC interface. Properly used, this device will provide years of reliable service.

## Specifications





### General Specifications

<b>Circuit</b>	Custom one-chip LSI microprocessor circuit
<b>Display</b>	0.6" (15mm) 6000 count LCD with function indicators
<b>Units of Measure</b>	mBAR, psi, kg/cm <sup>2</sup> , mm Hg, inches Hg, meter H <sub>2</sub> O, inches H <sub>2</sub> O and Atmospheres
<b>Input circuit</b>	Differential inputs (P1 and P2)
<b>Data Hold</b>	Freezes displayed reading
<b>Sensor</b>	Built-in piezoelectric sensors
<b>Zero Adjust</b>	Front panel push-button
<b>Sample rate</b>	0.8 sec. (approx.)
<b>Compatibility</b>	Air or non-corrosive and non-ionized gas
<b>Auto Power OFF</b>	Meter turns off after approx. 10 minutes to conserve energy
<b>Data Output</b>	RS-232 PC serial interface
<b>Ambient conditions</b>	32 to 122°F (0 to 50°C); < 80% RH
<b>Battery power</b>	9V alkaline battery
<b>Power Consumption</b>	8mA DC (approx.)
<b>Dimensions</b>	7.1 x 2.8 x 1.3" (180 x 72 x 32 mm)
<b>Weight</b>	0.46 lbs (210 g) meter only
<b>Accessories</b>	Quick-disconnect fittings (2), rubber jacket, and 9V battery

### Range Specifications

Range/Units (Max.)	Resolution	Accuracy
± 2000 mbar	1	± 2% full scale @ 23±5°C  Note: Accuracy includes linearity, hysteresis and repeatability effects
± 29 psi	0.01	
± 2.040 Kg/cm <sup>2</sup>	0.001	
± 1500 mm Hg	1	
± 59.06 inches Hg	0.02	
± 20.40 meters H <sub>2</sub> O	0.01	
± 802 inches H <sub>2</sub> O	0.5	
± 1.974 atmospheres	0.001	

## Meter Description

1. LCD Display – Indicates the measurement data, unit of measure, and user alert symbols as described in this manual
2. Push-buttons:
  -  POWER – Press to turn the meter ON or OFF
  -  HOLD – Press to freeze the displayed reading
  -  ZERO – Press to null the display (with fittings disconnected)
  -  RECORD/RECALL – Press to access the MIN/MAX recording mode as described later in this manual
  -  UNIT – Press to select the unit of measure
3. 0.16" (4mm) Quick-disconnect fittings (supplied)
4. P1 Input – 0.16" (4mm) accepts quick disconnect connector
5. RS-232 PC interface jack (3.5mm) – For use with data acquisition software/hardware interface kit model 407001
6. P2 input – 0.16" (4mm) accepts quick disconnect connector
7. Rubber protective holster (removable)
8. Battery compartment (on rear) – Remove rubber jacket to access compartment

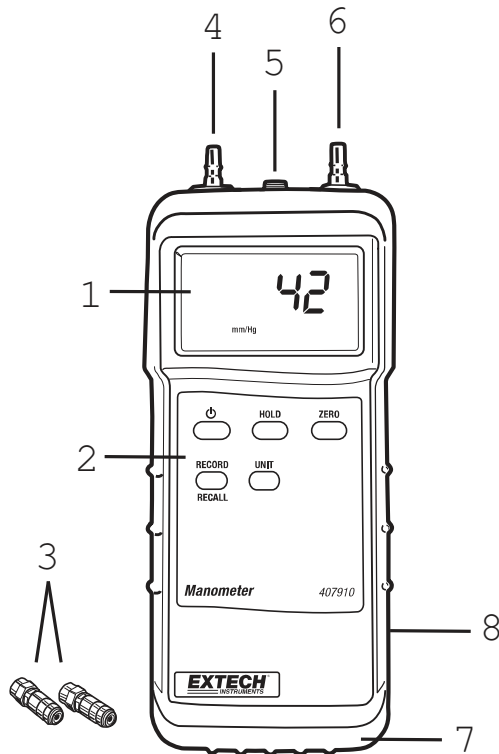

## Basic Operation

---

### Meter Power

This device uses a 9V battery for power. If the meter does not switch on when the POWER button is pressed or if the display shows **LBT**, replace the battery (refer to the Battery Replacement section later in this manual).

In order to conserve battery life, the meter has an automatic power off feature (after 10 minutes). To defeat this feature, access the RECORD mode by pressing the RECORD/RECALL button. In the RECORD mode, the meter will remain on until the user turns it off or until the battery weakens.

### Unit of measure

Press the UNIT button to select the unit of measure. This meter offers eight (8) units of measure as listed below, in the specifications chart earlier in this manual, and on the face-plate of the meter.

Units	Displayed Symbol
MBAR	"m" at bottom of the LCD and "Bar" at the top
Kg/cm <sup>2</sup>	Kg /cm <sup>2</sup>
mm of Hg	mm /Hg
m H <sub>2</sub> O	m H <sub>2</sub> O
Atmospheres	ATP
PSI	PSI
Inches of Hg	in/Hg
Inches of H <sub>2</sub> O	inch H <sub>2</sub> O

### Zero Adjust and Offset function

Before use and without fittings attached to the meter, press the ZERO button to calibrate the meter's circuitry. The display should then indicate zero.

If it is desired to offset the meter's display, press the ZERO button while taking a measurement. Subsequent readings will be the difference between the current measurement and the measurement that was on the display when the ZERO button was pressed.

### Fittings Connection

Connect tubing to the quick-disconnect fittings and then snap the supplied quick-disconnect fitting(s) to the P1, P2 (or both) input port(s). If both inputs are used (differential mode), the meter displays a positive pressure reading if the P1 pressure is greater than P2 and a negative reading if P2 is greater than P1.

### **MIN/MAX Record/Recall Mode**

The Record/Recall function tracks the maximum and minimum readings for recall at any time.

1. Press the RECORD/RECALL button once. The REC indicator will appear on the display.
2. Press the RECORD/RECALL button again to view the highest (MAX) reading taken since the RECORD/RECALL button was first pressed. The MAX indicator and maximum reading will appear on the display.
3. Press the RECORD/RECALL button again, the MIN indicator and the minimum value will appear on the display.
4. To return to normal operation, press and hold the RECORD/RECALL button until the display indicators REC, MAX, and MIN disappear.

### **RS-232 PC Interface**

The meter has a built-in RS-232 serial port. For streaming of data to a PC via the RS232 Output jack, the optional 407001-USB kit (RS232 to USB cable and driver CD) along with the 407001 software (available free at [www.extech.com](http://www.extech.com)) are required.

## **Battery Replacement**

---

When the low battery indicator **LBT** appears on the display or if the meter does not switch on when the **POWER** button is pressed, it is necessary to replace the battery.

To replace the battery:

1. Remove the meter's rubber protective jacket by stretching it over the bottom of the meter.
2. Pry open the battery compartment located on the back of the meter using a small coin or screwdriver.
3. Replace the 9V alkaline battery
4. Replace the battery compartment cover and the protective jacket.

## **Useful Conversions**

---

<b>Useful conversion Factors</b>		
<b>From</b>	<b>To</b>	<b>Multiplier</b>
In of H <sub>2</sub> O	In of Hg	0.07355
In of H <sub>2</sub> O	Cm of Hg	2.54
mm of Hg	In of H <sub>2</sub> O	0.03937

## Warranty

FLIR Systems, Inc. warrants its Exttech Instruments and devices to be free of defects in parts and workmanship for one year from date of shipment (six month limited warranty applies to sensors and cables). If it should become necessary to return the instrument for service during or beyond the warranty period, contact the Customer Service Department for authorization. Visit the website [www.extech.com](http://www.extech.com) for contact information. A Return Authorization (RA) number must be issued before any product returned. The sender is responsible for shipping charges, freight, insurance and proper packaging to prevent damage in transit. This warranty does not apply to defects resulting from action of the user such as misuse, improper wiring, operation outside of specification, improper maintenance or repair, or unauthorized modification. FLIR Systems, Inc. specifically disclaims any implied warranties of merchantability or fitness for a specific purpose and will not be liable for any direct, indirect, incidental or consequential damages. FLIR's total liability is limited to repair or replacement of the product. The warranty set forth above is inclusive and not other warranty, whether written or oral, is expressed or implied.

## Calibration, Repair, and Customer Care Services

FLIR Systems, Inc. offers repair and calibration services for the Exttech Instruments products we sell. NIST certification for most products is also provided. Call the Customer Service Department for information on calibration services available for this product. Annual calibrations should be performed to verify meter performance and accuracy. Technical support and general customer service is also provided, refer to the contact information provided below.

Support Lines: U.S. (877) 439-8324; International: +1 (603) 324-7800

Technical Support: Option 3; E-mail: [support@extech.com](mailto:support@extech.com)

Repair & Returns: Option 4; E-mail: [repair@extech.com](mailto:repair@extech.com)

Product specifications are subject to change without notice.

Please visit our website for the most up-to-date information.

[www.extech.com](http://www.extech.com)

FLIR Commercial Systems, Inc., 91 Townsend West, Nashua, NH 03063 USA

ISO 9001 Certified

Copyright © 2014 FLIR Systems, Inc.

All rights reserved including the right of reproduction in whole or in part in any form.

[www.extech.com](http://www.extech.com)

## Garantie

FLIR Systems, Inc. garantit que cet appareil Exttech Instruments est exempt de défauts matériaux de fabrication pendant un an à partir de la date d'envoi. Une garantie limitée de six mois s'applique aux capteurs et aux câbles. Si le renvoi de l'appareil pour réparation devient nécessaire durant ou après la période de garantie, contactez le service client pour autorisation. Pour obtenir les coordonnées, visitez le site Web suivant [www.extech.com](http://www.extech.com). Un numéro d'autorisation de retour (AR) doit être délivré avant tout retour de produit. L'expéditeur prend à sa charge les frais d'expédition, le fret, l'assurance et l'emballage correct de l'appareil afin de prévenir toute détérioration durant le transport. Cette garantie ne s'applique pas aux dommages imputables à l'utilisateur, tels que l'usage impropre ou abusif, un mauvais câblage, une utilisation non conforme aux spécifications, un entretien ou une réparation incorrecte, ou toute modification non autorisée. FLIR Systems, Inc. déclinera spécifiquement toute garantie de qualité marchande ou aptitude à l'emploi prévu, et ne sera en aucun cas tenue responsable pour tout dommage conséquent, direct, indirect ou accidentel. La responsabilité totale de FLIR est limitée à la réparation ou au remplacement du produit. La garantie définie ci-dessus est l'unique et la seule garantie écrite ou orale, et est exprimée de manière implicite.

## Calibrage, réparation et services après-vente

FLIR Systems, Inc. offre des services de calibrage et de réparation pour les produits Exttech Instruments que nous commercialisons. Nous fournissons également une certification NIST pour la plupart des produits. Contactez notre service client pour toute information sur les services de calibrage disponibles pour ce produit. Un calibrage doit être effectué chaque année pour vérifier les performances et la précision du mètre. Nous offrons également une assistance technique et un service à la clientèle. Veuillez vous reporter aux coordonnées fournies ci-dessous.

Lignes d'assistance: États-Unis (877) 439-8324; international: +1 (603) 324-7800

Service d'assistance technique: Option 3 | E-mail [support@extech.com](mailto:support@extech.com)

Réparations et retours: Option 4 | E-mail [repair@extech.com](mailto:repair@extech.com)

Les spécifications produit sont sujettes à modifications sans préavis.

Pour les toutes dernières informations, veuillez visiter notre site Web:

[www.extech.com](http://www.extech.com)

FLIR Commercial Systems, Inc., 91 Townsend West, Nashua, NH 03063 USA

Certifié ISO 9001

Copyright © 2014 FLIR Systems, Inc.

Tous droits réservés. Toute reproduction partielle ou totale sous quelque forme que ce soit.

[www.extech.com](http://www.extech.com)



## Garantía

FJRS Systems, Inc., garantiza este dispositivo marca Extech Instruments para estar libre de defectos en partes o mano de obra durante un año a partir de la fecha de embarque (se aplica una garantía limitada de seis meses para cables y sensores). Si fuera necesario regresar el instrumento al servicio durante el periodo de garantía, llame al Departamento de Servicio al Cliente para obtener la autorización. Visite [www.extech.com](http://www.extech.com) para información de contacto. Se debe expedir un Número de Autorización de Evolución (AE) antes de regresar cualquier producto. El remitente es responsable de los gastos de embarque, flete, seguro y el paquete apropiado para prevenir daños en tránsito. Esta garantía no se aplica a defectos resultantes de las acciones del usuario como el mal uso, el uso de un equipo equivocado, la operación fuera de las especificaciones, el mantenimiento o la reparación inadecuada o modificación no autorizada. FJRS Systems, Inc., rechaza específicamente cualquier garantía implícita de factibilidad de comercialización o idoneidad para cualquier propósito determinado y no será responsable por cualesquier daños directos, indirectos, incidentales o consecuentes. La responsabilidad total de FJRS es limitada a la reparación o reemplazo del producto. La garantía precedente es inclusiva y no hay otra garantía ya sea escrita o verbal, expresa o implícita.

## Servicios de calibración, reparación y atención al cliente

FJRS Systems, Inc., ofrece servicios de reparación y calibración para los productos que vendemos de Extech Instruments. Además ofrecemos certificación NIST para la mayoría de los productos. Llame al Departamento de Servicio al Cliente para solicitar información de calibración para este producto. Para verificar el funcionamiento y precisión se debe realizar la calibración anual. Además se provee el Soporte Técnico y Servicios Generales al Cliente, consulte la información de contacto en seguida.

Líneas de soporte: EE.UU. (877) 439-8324; Internacional: +1 (603) 324-7800

Soporte Técnico Opción 3, correo electrónico: [Support@extech.com](mailto:Support@extech.com)

Reparación y Devoluciones: Opción 4, correo electrónico: [Repair@extech.com](mailto:Repair@extech.com)

Las especificaciones del producto están sujetas a cambios sin aviso

Por favor visite nuestra página en internet para la información más actualizada

[www.extech.com](http://www.extech.com)

FJRS Commercial Systems, Inc., 91 Townsend West, Nashua, NH 03063 USA

Certificado ISO 9001

Copyright © 2014 FJRS Systems, Inc.

Reservados todos los derechos, incluyendo el derecho de reproducción total o parcial en cualquier medio

[www.extech.com](http://www.extech.com)