

5 in 1 Environmental Meter

Model: EN300

Anemometer
Humidity Meter
Light Meter
Thermometer
Sound Level Meter



Introduction











Congratulations on your purchase of this Extech Meter. The EN300 is five professional meters built into one convenient package. This meter ships fully tested and calibrated and, with proper use, should provide many years of reliable service.

Features

This 5-in-1 professional measuring instrument provides the following functions:

1. Anemometer uses a low-friction ball bearing mounted wheel design for high accuracy.
2. Humidity meter uses a high precision humidity sensor for fast response time.
3. Light meter uses a photo diode and color correction filter light sensor; spectrum meets C.I.E. photopic.
4. Type K thermometer uses standard type K (NiCr-NiAl) thermocouple input jack suitable for diverse application type K probes.
5. The sound level meter meets IEC 61672 class 2 with "A" frequency weighting and "Fast" time response.

Common Features:

-  Built-in microprocessor circuit assures excellent performance and accuracy.
-  Concise and compact button arrangement for ease of operation.
-  Record / recall maximum and minimum values.
-  Hold function freezes the current reading value.
-  Front panel °C / °F selection button.
-  Front panel Lux/Foot-candle selection button.
-  Five (5) air velocity measurement units, selected by a front panel button.
-  Dual display with simultaneous display of relative humidity and temperature or air velocity and temperature.
-  Zero button for light meter.
-  Robust housing suitable for one hand operation

Safety

International Safety Symbols











This symbol, adjacent to another symbol or terminal, indicates the user must refer to the manual for further information.



Double insulation

Cautions

-  Improper use of this meter can cause damage, shock, injury or death. Read and understand this user manual before operating the meter.
-  Inspect the condition of the probe and the meter itself for any damage before operating the meter. Repair or replace any damage before use.
-  If the equipment is used in a manner not specified by the manufacturer, the protection provided by the equipment may be impaired.
-  This device is not a toy and must not reach children's hands. It contains hazardous objects as well as small parts that the children could swallow. In case a child swallows any of them, please contact a physician immediately
-  Do not leave batteries and packing material lying around unattended; they can be dangerous for children if they use them as toys
-  In case the device is going to be unused for an extended period of time, remove the batteries to prevent them from draining
-  Expired or damaged batteries can cause cauterization on contact with the skin. Always, therefore, use suitable hand gloves in such cases
-  See that the batteries are not short-circuited. Do not throw batteries into the fire.

Meter Description

1. Microphone
2. Light Sensor
3. LCD display
4. Hold Button
5. Power Button
6. Unit / Zero Button
7. Air Speed Sensor
8. Thermocouple Input Socket I
9. RS-232 Output Terminal
10. DC power adaptor socket
11. Max. / Min. Button
12. Function Button
13. °C/°F Button/Lux/Ft-cd Button
14. On rear: Battery Compartment, Tripod mount, Stand

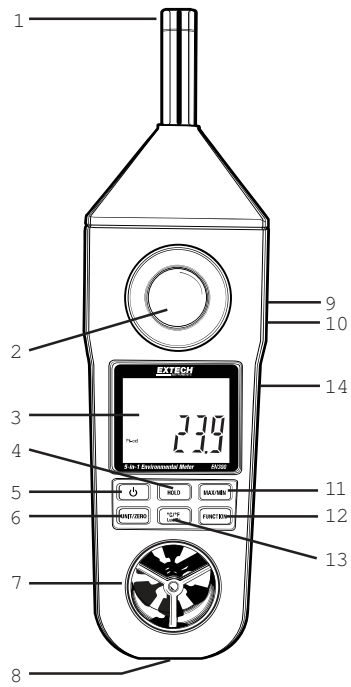

Operation

Powering the meter

1. Press the Power button to turn the instrument ON
2. If the meter does not turn on or if the " " low battery symbol appears in the display, replace the batteries.
3. Press the Function button to select the measurement needed.

Note: The display orientation rotates, depending on the function selected.
Microphone up: Sound, Light, Temperature
Air speed sensor up: Airspeed + Temperature, Humidity + Temperature

Anemometer Air Velocity Measurement

1. Select the Anemometer function by pressing "Function Button" until the display indicates Anemometer units (ft/min, m/s, km/h, MPH, or knots).
2. Press the "Unit/Zero Button" to select unit desired
3. Press the "°C/°F Button" to select the temperature unit.
4. Face the air velocity sensor into the source of wind.
5. The display will show the air velocity and the ambient temperature.
6. Allow time for the reading to stabilize and note the values indicated. Air velocity may fluctuate slightly.

Temperature Measurement (Thermocouple)

1. Plug a type K thermocouple probe into the "Thermocouple Input Socket".
2. Select the temperature function by pressing "Function Button" until the display shows temperature units (°C or °F).
3. Contact the Thermocouple Sensor Head with object to be measured
4. The temperature value will be displayed on the LCD display.

Note: Verify the polarity when plugging a thermocouple probe into the temperature input socket.

Any temperature difference between thermocouple probe and thermometer can result in inaccurate measurement result. Therefore, allow time for thermal equalization between probe plug and meter input socket. The thermal equalization procedure takes few minutes and should be applied only when the probe has been exposed to ambient temperature different from the meter

Hygrometer Humidity & Ambient Temperature Measurement

1. Select the Relative Humidity function by pressing "Function Button" until the display indicates %RH.
2. The humidity and temperature readings will be displayed on the LCD.
3. When the meter is placed into a new environment, a few minutes are required to reach a stable condition.

Light Measurement

1. Select the Light Measurement function by pressing the "Function Button" until a light unit (Lux or Ft-cd) is displayed.
2. Press the "Lux/Ft-cd Button" to switch between "Lux" or "Ft-cd".
3. The Display will show the light value

Zero Offset calibration of Light Function:

For best results, zero the light sensor prior to use in a dark environment. To accomplish this, completely cover the light sensor and then press the "Unit/Zero Button".

The zero point can drift due to environment temperature and battery power change. It is recommended that the zero be checked frequently using the above procedure.

Sound Level Measurement

1. Select the Sound Level function by pressing the "Function Button" until the Sound level unit (dB) is displayed.
2. Hold the instrument in one hand and point the microphone towards the noise source. The sound level value (dB) will be displayed on the LCD.

Changing °C / °F units

During temperature measurements, press the °C / °F button once to change the temperature units from "°C" to "°F".

Hold Function

Press the "Hold Button" to freeze the current reading value, "HOLD" symbol appears on the display. Press the button again to continue normal operation.

Data Record Function

1. The Data Record function records & displays the maximum and minimum reading values. Start the Data Record function by pressing the "Max/Min Button" once. The "REC" symbol appears on the display.
2. With the REC symbol on the display :
 - (a) Press the "Max/Min Button" once and the "Max" symbol along with the maximum value will appear on the display.
 - (b) Press the "Max/Min Button" again; the "Min" symbol along with the minimum value will appear on the display.
 - (c) To exit the memory record function, press the "Max/Min Button" continuously for at least 2 seconds. The display will revert to the current reading.
 - (d) Clear the Max/Min value recorded by pressing the "Hold Button" once. Previous recorded Max/Min values will be erased and then return to REC function and continue recording.

Auto Power-off

To prolong the life of the batteries, the instrument has an "Auto Power-off" function. The meter will automatically switch off if there are no button presses in any 10-minute period.

RS232 port

The RS232 port is used to send measurement data to a PC.

Battery Replacement

1. When the LCD display shows "" symbol, it is necessary to replace the battery. However, measurement may still be made for several hours after the low battery indicator appears.
2. Remove the two battery cover screws and remove the battery cover.
3. Install fresh batteries DC 1.5 V battery, UM4/AAA x 6 PCs, and reinstall the cover.

You, as the end user, are legally bound (Battery ordinance) to return all used batteries and accumulators; disposal in the household garbage is prohibited!

You can hand over your used batteries / accumulators at collection points in your community or wherever batteries / accumulators are sold



Disposal: Follow the valid legal stipulations in respect of the disposal of the device at the end of its lifecycle

Specifications

General Specifications

Display	LCD display, LCD size: 41.5 x 31.5 mm.
Measurement	5 in 1 : Anemometer (Air velocity + Temperature) Humidity (%RH + Temperature) Light Thermometer (type K) Sound level
Operating Humidity	80%RH Max.
Operating Temperature	0 to 50°C (32 to 122°F)
Over Input Display	Indication of "- - - -"
Data Output	RS 232/USB PC serial interface
Power Supply	1.5 DC V battery (UM4, AAA) x 6 PCs, 9V DC adapter input. (AC power adapter is optional).
Power Consumption	Anemometer: Approx. DC 11 mA Other functions: Approx. DC 7.5 mA
Weight	335 g/0.74 lb (battery included).
Dimension	HWD 248 x 70 x 34 mm (9.8 x 2.8 x 1.3 inch).

Electrical Specifications

Anemometer (Air velocity/Temperature)

Units	Range	Res.	Accuracy
ft/min	80 to 5910ft/min	1	≤3900ft/min: ± 3% F.S., >3900ft/min:± 4% F.S.
m/s	0.4 to 30.0m/s	0.1	≤20m/s : ± 3% F.S., > 20m/s : ± 4% F.S.
km/h	1.4 to 108.0km/h	0.1	≤72km/h: ± 3% F.S., >72km/h:± 4% F.S.
MPH	0.9 to 67.0mile/h	0.1	≤45mile/h: ± 3% F.S.,>45mile/h:± 4% F.S.
knots	0.8 to 58.3 knots	0.1	≤39 knots: ± 3% F.S.,>39 knots:± 4% F.S.
°F	32 to 122°F	0.1	± 2.5°F
°C	0 to 50°C	0.1	± 1.2°C

Type K Thermocouple Thermometer

Units	Range	Resolution	Accuracy
°F	-148 to 2372 °F	0.1 °F	± (1% rdg + 2 °F)
°C	-100 to 1300 °C	0.1 °C	± (1% rdg + 1 °C)

Note: The type K thermocouple probe is optional

Hygrometer (Humidity/Temperature)

Units	Range	Resolution	Accuracy
%RH	10 to 95 %RH	0.1 %RH	< 70 %RH :± 4 %RH ≥ 70 %RH :± (4%rdg + 1.2 %RH)
°F	32 to 122°F	0.1°F	± 2.5°F
°C	0 to 50°C	0.1°C	± 1.2°C

Light

Units	Range	Resolution	Accuracy
Lux	0 to 2,200 Lux	1 Lux	± 5% rdg ± 8 digits
	1,800 to 20,000 Lux	10 Lux	
Ft-cd	0 to 204.0 Fc	0.1 Ft-cd	
	170 to 1,860 Fc	1 Ft-cd	

Sound Level

Microphone 1/2" Electret condenser microphone
 Measurement Range 35 to 130 dB, Auto range
 Resolution 0.1dB
 Frequency response 31.5Hz to 8,000Hz
 Weighting " A " frequency weighting network
 Time Response "Fast"
 Accuracy Meets IEC 61672 class 2, A weight, Fast response

Note: Stated specification tests under the environment RF Field Strength less than 3 V/M & frequency less than 30 MHz only

Note: Specification stated for 23± 5°C



Copyright © 2014 **EXTECH** Systems, Inc. 
 All rights reserved including the right of reproduction in whole or in part in any form 
 ISO-9001 Certified 

www.extech.com 