

Vibration Meter

SD Card real-time datalogger

Model SDL800



Introduction

Congratulations on your purchase of the Extech SDL800 Vibration Meter. This meter displays and stores vibration readings of Acceleration, Velocity and Displacement. Supported measurement units are meters/s², ft/s², g, mm/s, cm/s, in/s, mm and inch. Logged data readings are stored on an SD card for transfer to a PC. This meter is shipped fully tested and calibrated and, with proper use, will provide years of reliable service.





Safety

International Safety Symbols



This symbol, adjacent to another symbol or terminal, indicates the user must refer to the manual for further information.

Meter Description



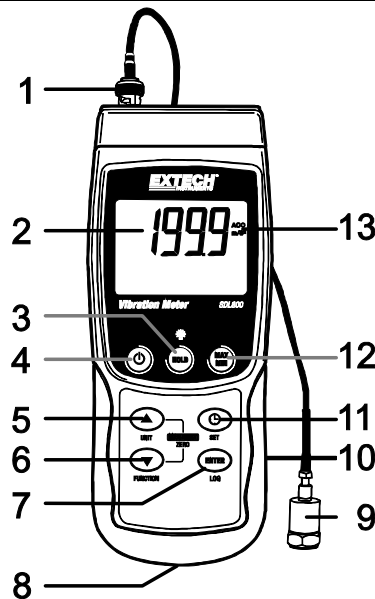

1. Vibration pickup input jack
2. Measurement Display
3. HOLD and Backlight  key
4. Power ON-OFF  key
5. Up arrow  / UNIT key
6. Down arrow  / Function key
7. ENTER and LOG key
8. SD card slot
9. Vibration pickup
10. DC Adaptor socket, Reset key and Data output jack
11. SET and Clock  key
12. MAX-MIN key
13. Unit of measure Display



Notes: Items listed in "10" are located behind the snap-off compartment cover on meter's right side. Battery compartment, tilt stand, and tripod mount are located on the rear of the instrument

Getting Started

Power ON-OFF

-  Power the meter by pressing and holding the power button  for at least 1.5 seconds.
-  Press and hold the power button for at least 1.5 seconds to power OFF the meter.
-  This meter is powered by six (6) 1.5VDC 'AA' batteries or by optional AC adaptor. If the meter will not switch ON please check that fresh batteries are installed in the rear battery compartment or, in the case of the AC adaptor, check that the adaptor is connected correctly to the meter and to an AC source.

Display Backlight

To turn the display backlight ON or OFF, press and hold the backlight  button for at least 1.5 seconds. The meter will beep when switching the backlight ON or OFF unless the beeper is disabled.

Vibration Sensor

Connect the vibration pickup to the cable supplied. Make sure it is firmly attached.

Connect the cable to the meter by attaching it to the BNC connector on the top of the meter.

If the surface to be tested is magnetic, attach the magnetic base to the vibration pickup and attach the pickup to a flat surface.

If the surface to be tested is not magnetic, hold the pickup against the surface. Do not hold the cable while making measurements.

Units of Measure

The currently selected unit of measure is shown on the meter's LCD. To change the unit of measure, press and hold the UNIT button until the desired unit of measure appears and then release the UNIT button. The meter begins scrolling through the available units of measure after the UNIT button has been depressed for at least 1.5 seconds. The saved units will become the default turn-on units.

UNIT	DISPLAY INDICATOR
ACC	m/s ²
	g
VEL	mm/s
	cm/s
DISP p-p	mm
ACC	ft/s ²
VEL	ln/s
DISP p-p	inch

Function Selection

The currently selected function is shown on the meter's LCD. To change the function, press and hold the FUNCTION button until the desired function appears, then release the FUNCTION button.

The available functions are:

- RMS: typical selection for Acceleration and Velocity
- PEAK: displays the peak value of the vibration
- MAX HOLD: displays and holds the max value measured

MAX HOLD Reset

Press and hold the ▲ and ▼ buttons for 1.5 seconds to clear the max Hold reading.

Data Hold

To freeze a displayed reading on the LCD, momentarily press the HOLD button (the HOLD icon will appear above the reading). To exit HOLD, press the HOLD button again.

ZERO Adjustment

The ZERO function is used to remove any small offset caused by temperature changes or other environmental changes. The zero will only work for a display of 10 or less digits.

1. Connect the vibration sensor to the meter
2. Set the measurement function to Acceleration
3. Make sure the sensor is motionless and not subject to any vibrations
4. Press and Hold the ▼ and ▲ buttons for 1.5 seconds and the meter will zero

Max-Min Reading Record

For a given measurement session, this meter can record the highest (MAX) and the lowest (MIN) readings for later recall.

1. Press the MAX-MIN button momentarily to access this mode of operation (REC icon appears)
2. The meter is now recording the MAX and MIN readings.
3. Press the MAX-MIN button again to view the current MAX readings (MAX icon appears). The readings on the display are now the highest readings encountered since the REC icon was switched on (when the MAX-MIN button was first pressed).
4. Press the MAX-MIN button again to view the current MIN readings (MIN icon appears). The readings on the display are now the lowest readings encountered since the REC icon was switched on (when the MAX-MIN button was first pressed).
5. To exit the MAX-MIN mode, press and hold the MAX-MIN button for at least 1.5 seconds. The meter will beep, the REC-MAX-MIN icons will switch off, the MAX-MIN memory will clear, and the meter will return to the normal operating mode.

Setup Mode

Basic settings at a glance

To view the current configuration of the meter with regard to time, date, and datalogging sampling rate press the SET button momentarily. The meter will now display the configuration in quick succession. If the information is missed on the first try, simply press the SET button again until all of the information is noted.

Accessing the Setup mode

1. Press and hold the SET button for at least 1.5 seconds to access the Setup menu.
2. Press the SET button momentarily to step through the available parameters. The parameter type is shown on the bottom of the LCD and the current selection for that type is shown above it.
3. When a parameter is displayed that is to be changed, use the arrow keys to change the setting. Press the ENTER button to confirm a change.
4. Press and hold the SET button for at least 1.5 seconds to exit the Setup mode. Note that the meter automatically switches out of the Setup mode if no key is pressed within 7 seconds.
5. The available Setup parameters are listed below. Additional detailed information is provided below this list:

dAtE Set the clock (Year/Month/Date; Hours/Minutes/Seconds)

SP-t Set the datalogger sampling rate

PoFF Automatic power-off management (Enable or disable the auto-power off function)

bEEP Set the beeper sound ON/OFF

dEC Set the numerical format; USA (decimal: 20.00) or European (comma: 20,00)

SdF Format the SD memory card

Setting the Clock Time

1. Access the **dAtE** parameter.
2. Use the ENTER button to step through the selections (year, month, day, hour, minute, second)
3. Use the arrow keys to change a value
4. Press and hold the SET button for at least 1.5 seconds to exit to the normal operation mode (or simply wait 7 seconds for the meter to automatically switch to the normal operating mode).
5. The clock will keep accurate time even when the meter is switched off. However, if the battery expires the clock will have to be reset after fresh batteries are installed.

Setting the Datalogger Sampling Time (Rate)

1. Access the **SP-t** parameter.
2. The sampling rate can be set to 0, 1, 2, 5, 10, 30, 60, 120, 300, 600, 1800 or 3600 seconds.
3. Use the arrow keys to change the digit values.
4. Press the ENTER button to confirm the entry.
5. Press and hold the SET button for at least 1.5 seconds to exit to the normal operation mode (or simply wait 7 seconds for the meter to automatically switch to the normal operating mode).

Enabling/Disabling the Auto Power OFF Feature

1. Access the **PoFF** parameter.
2. Use the arrow buttons to select ON or OFF. With the Auto Power OFF feature enabled, the meter will automatically switch OFF after 10 minutes of inactivity.
3. Press ENTER to confirm setting.
4. Press and hold the SET button for at least 1.5 seconds to exit to the normal operation mode (or simply wait 7 seconds for the meter to automatically switch to the normal operating mode).

Set the Beeper Sound ON or OFF

1. Access the **bBEEP** parameter.
2. Use the arrow buttons to select ON or OFF.
3. Press ENTER to confirm setting.
4. Press and hold the SET button for at least 1.5 seconds to exit to the normal operation mode (or simply wait 7 seconds for the meter to automatically switch to the normal operating mode).

Numerical Format (comma or decimal)

European and USA numerical formats differ. The meter defaults to USA mode where a decimal point is used to separate units from tenths, i.e. **20.00**; The European format uses a comma, i.e. **20,00** to separate units from tenths. To change this setting:

1. Access the **dEC** parameter.
2. Use the arrow buttons to select USA or EUro.
3. Press ENTER to confirm setting.
4. Press and hold the SET button for at least 1.5 seconds to exit to the normal operation mode (or simply wait 7 seconds for the meter to automatically switch to the normal operating mode).

SD Card FORMATTING

1. Access the **Sd-F** parameter.
2. Use the arrow buttons to select YES to format the card (select NO to abort). Note that all data on the card will be lost if formatting is attempted.
3. Press ENTER to confirm selection.
4. Press ENTER again to re-confirm.
5. The meter will automatically return to the normal operating mode when formatting is complete. If not, press and hold the SET button for at least 1.5 seconds to exit to the normal operation mode.



System Reset

If the meter's keys become inoperable or if the display freezes, the Reset button can be used to reset the instrument.



1. Use a paper clip or similar item to momentarily press the reset button located on the lower right side of the instrument .
2. After pressing the Reset button, switch the instrument ON by pressing and holding the POWER key for at least 1.5 seconds. If using the power adaptor unplug the adaptor and then plug it back in again to power the meter.

Datalogging

Types of Data Recording

-  **Manual Datalogging:** Manually log up to 99 readings onto an SD card via push-button press.
-  **Automatic Datalogging:** Automatically log data onto an SD memory card where the number of data points is virtually limited only by the card size. Readings are logged at a rate specified by the user.

SD Card Information

-  Insert an SD card (from 1G size up to 16G) into the SD card slot at the bottom of the meter. The card must be inserted with the front of the card (label side) facing toward the rear of the meter.
-  If the SD card is being used for the first time it is recommended that the card be formatted and the logger's clock set to allow for accurate date/time stamping during datalogging sessions. Refer to the Setup Mode section for SD card formatting and time/date setting instructions.
-  European and USA numerical formats differ. The data on the SD card can be formatted for either format. The meter defaults to USA mode where a decimal point is used to separate units from tenths, i.e. **20.00**. The European format uses a comma, i.e. **20,00**. To change this setting, refer to the Setup Mode section.

Manual Datalogging

In the manual mode the user presses the LOG button to manually log a reading onto the SD card.

1. Set the sampling rate to '0' seconds as described in the Setup Mode section.
2. Press and hold the LOG button for at least 1.5 seconds and the DATALOGGER icon will appear on the LCD; the lower portion of the display will show p-n (n = memory position number 1-99).
Note that if PSI is set as the unit of measure it appears as P51 (where a '5' is used as an 'S') in the same area of the LCD where memory locations are shown. This can be disorienting at first.
3. Momentarily press the LOG button to store a reading. The DATALOGGER icon will flash each time a data point is stored.
4. Use the ▲ and ▼ buttons to select one of the 99 data memory positions in which to record.
5. To exit the manual datalogging mode, press and hold the LOG button for at least 1.5 seconds. The DATALOGGER icon will switch off.

Automatic Datalogging

In automatic datalogging mode the meter takes and stores a reading at a user-specified sampling rate onto an SD memory card. The meter defaults to a sampling rate of two seconds. To change the sampling rate, refer to the Setup Mode section (the sampling rate cannot be '0' for automatic datalogging):

1. Select the sampling rate in the Setup Mode to a value other than zero.
2. Press and hold the LOG button for at least 1.5 seconds. The meter will flash the DATALOGGER icon at the selected sampling rate indicating that readings are now being automatically recorded to the SD card.
3. If a card is not inserted or if the card is defective, the meter will display SCAN SD indefinitely. In this case, switch the meter OFF and try again with a valid SD card.
4. Pause the datalogger by pressing the LOG button momentarily. The DATALOGGER icon will stop flashing and the sample rate will display for a short time. To resume logging simply press the LOG button again momentarily.
5. To terminate the datalogging session press and hold the LOG button for at least 1.5 seconds.
6. When an SD card is used for the first time a folder is created on the card and named **VBD01**. Up to 99 spreadsheet documents (each with 30,000 readings) can be stored in this folder.
7. When datalogging begins a new spreadsheet document named **VBD01001.xls** is created on the SD card in the VBD01 folder. The data recorded will be placed in the VBD01001.xls document until 30,000 readings are reached.
8. If the measurement session exceeds 30,000 readings, a new document will be created (VBD01002.xls) where another 30,000 readings can be stored. This method continues for up to 99 documents, after which another folder is created (VBD02) where another 99 spreadsheet documents can be stored. This process continues in this same fashion with folders VBD03 through VBD10 (last allowable folder).

SD Data Card to PC Data Transfer

1. Complete a datalogging session as detailed in above in the previous sections. Hint: For the first few tests, simply record a small amount of test data. This is to ensure that the datalogging process is well understood before committing to critical, large scale datalogging.
2. With the meter switched OFF, remove the SD Card.
3. Plug the SD Card directly into a PC SD card reader. If the PC does not have an SD card slot, use an SD card adaptor (available at most outlets where computer accessories are sold).
4. Power the PC and run a spreadsheet software program. Open the saved documents in the spreadsheet software program (see example spreadsheet data screen below).

Spreadsheet data example

	A	B	C	D	E
19	Place	Date	Time	Value	Unit
20	1	2010/9/6	10:06:44	0.47	ACC g
21	2	2010/9/6	10:06:46	0.51	ACC g
22	3	2010/9/6	10:06:48	0.53	ACC g
23	4	2010/9/6	10:06:50	0.46	ACC g
24	5	2010/9/6	10:06:52	0.48	ACC g
25	6	2010/9/6	10:06:54	0.51	ACC g
26	7	2010/9/6	10:06:56	0.47	ACC g
27	8	2010/9/6	10:06:58	0.51	ACC g
28	9	2010/9/6	10:07:00	0.55	ACC g
29	10	2010/9/6	10:07:02	0.51	ACC g
30	11	2010/9/6	10:07:04	0.46	ACC g
31	12	2010/9/6	10:07:06	0.51	ACC g
32	13	2010/9/6	10:07:08	0.45	ACC g
33	14	2010/9/6	10:07:10	0.52	ACC g
34	15	2010/9/6	10:07:12	0.51	ACC g

RS-232/USB PC Interface





For streaming of data to a PC via the RS232 Output jack, the optional 407001-USB kit (RS232 to USB cable and driver CD) along with the 407001 software (available free at www.extech.com/sdl800) are required.

AC Power Adaptor

This meter is normally powered by six (6) 1.5V 'AA' batteries. An optional 9V power adaptor is available. When the adaptor is used, the meter is permanently powered and the power button will be disabled.

Battery Replacement and Disposal

When the low battery icon  appears on the LCD, the batteries must be replaced. Several hours of accurate readings are still possible in this condition; however batteries should be replaced as soon as possible:

-  Remove the two (2) Phillips screws from the rear of the meter (directly above the top of the tilt stand).
-  Remove and safely place the battery compartment and screws where they will not be damaged or lost.
-  Replace the six (6) 1.5V 'AA' batteries observing polarity.
-  Replace the battery compartment cover with the two (2) Phillips screws.



All EU users are legally bound by the battery ordinance to return all used batteries to collection points in your community or wherever batteries / accumulators are sold! Disposal in the household garbage is prohibited!

Specifications

Display	Backlit LCD; LCD size: 52 x 38mm (2 x 1.5")
Status indicators	Over-range audible beep and low battery display icon 
Frequency Range	10Hz to 1kHz
Datalogger Sampling Rate	AUTO LOGGING: From 1 to 3600 seconds. MANUAL LOGGING: Set the sampling rate to '0' seconds
Memory Card	SD memory card; 1G to 16GB size
Data Hold	Freeze the displayed reading
Memory Recall	Record and Recall the Maximum and Minimum readings
Display update rate	Approx. 1 second
Data Output	RS-232 / USB PC computer interface
Operating Temperature	0 to 50°C (32 to 122°F)
Operating Humidity	85% R.H. max.
Auto Power OFF	After 10 minutes of inactivity (can be disabled)
Power Supply	Six (6) 1.5 VDC batteries (optional 9V AC adaptor)
Power Consumption	Normal operation (backlight and datalogger OFF): approx. 5mAdc With backlight OFF and datalogging ON: approx. 25mAdc With backlight ON add approx. 12mAdc
Weight	343g (0.75 lbs.) w/ batteries; 241g (0.53 lbs.) w/o batteries
Dimensions	Meter: 182 x 73 x 47.5mm (7.1 x 2.9 x 1.9") Vibration sensor: round 16mm (0.63") diameter, 37mm (1.46") length

Electrical Specifications

Function	Unit	Range	Accuracy
Acceleration	m/s ²	0.5 to 199.9 m/s ²	± (5%rdg + 2 d) @ 80 and 160Hz
	g	0.05 to 20.39 G	
	ft/s ²	2 to 656 ft/s ²	
Calibration Point: 50 m/S^2 (160 Hz)			
Velocity	mm/s	0.5 to 199.9 mm/s	± (5%rdg + 2 d) @ 80 and 160Hz
	cm/s	0.05 to 19.99 cm/s	
	inch/s	0.02 to 7.87 inch/s	
Calibration Point: 50 mm/s (160 Hz)			
Displacement	mm	0.003 to 1.999 mm	± (5%rdg + 2 d) @ 80 and 160Hz
	inch	0.078 inch	
	Calibration Point: 0.141 mm (160 Hz)		

Above specification tests under the environment RF Field Strength less than 3 V/M & frequency less than 30 MHz only and 23±0.5°C

Copyright © 2013-2015 E.I.R.S. Systems, Inc. 

All rights reserved including the right of reproduction in whole or in part in any form. 

ISO-9001 Certified 

www.extech.com